

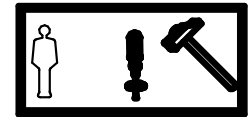

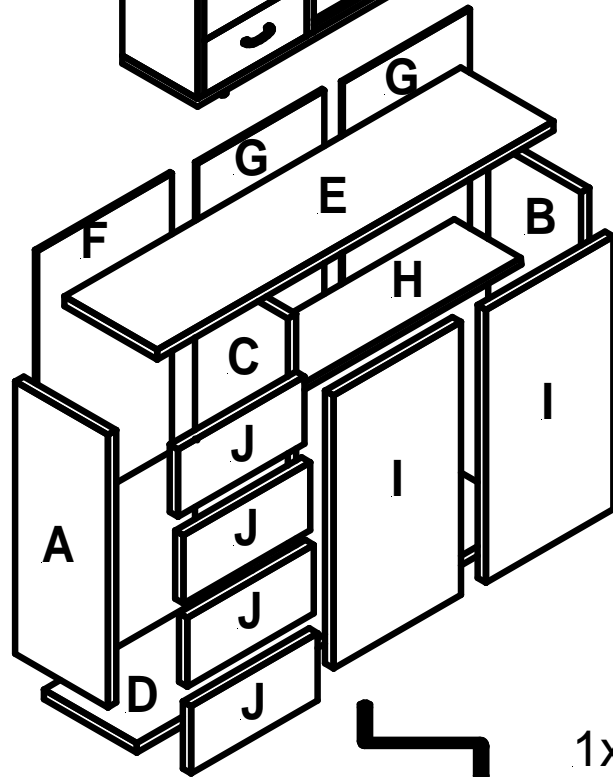

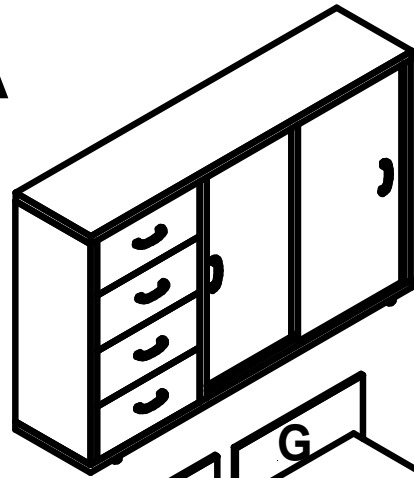









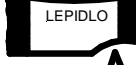

IDEA

61503



-  8x
-  40x
-  6x
-  6x
-  4x
-  6x
-  4x
-  4x
-  2x
-  8x

- a  1x
- b  1x
-  1x
-  1x
-  8x

1.)  6x

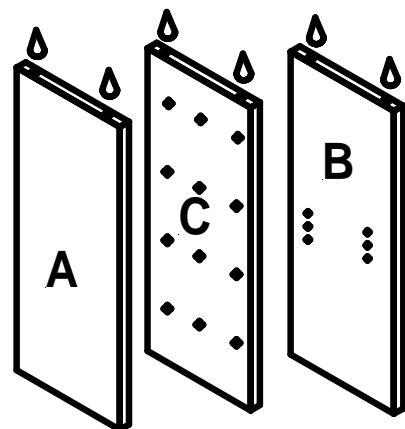

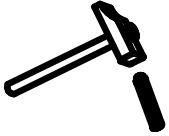
2.)  6x

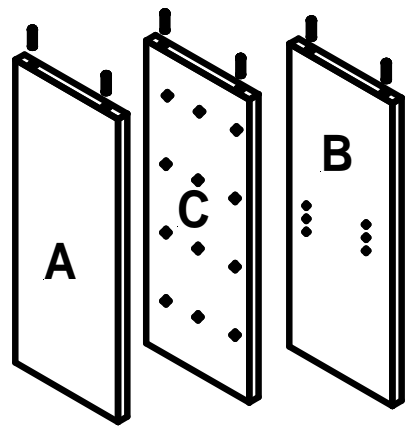

3.)  8x

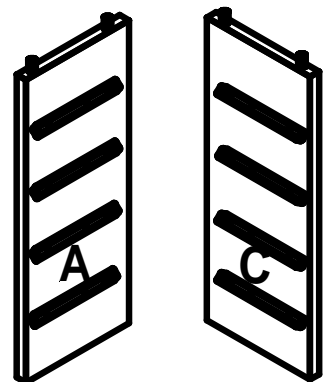

4.)  4x

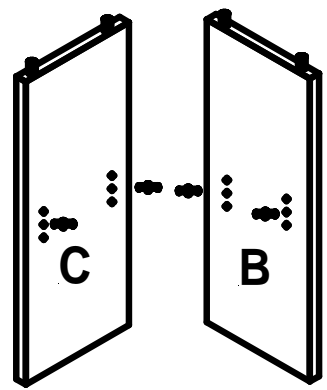

5.)

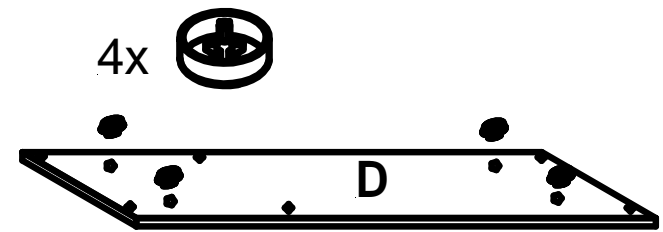

6.) 

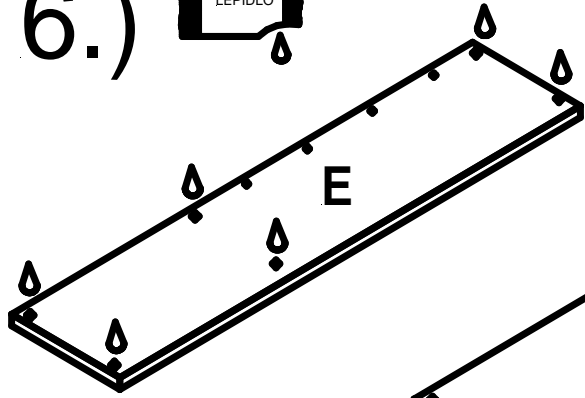

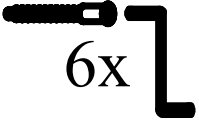
7.)  6x

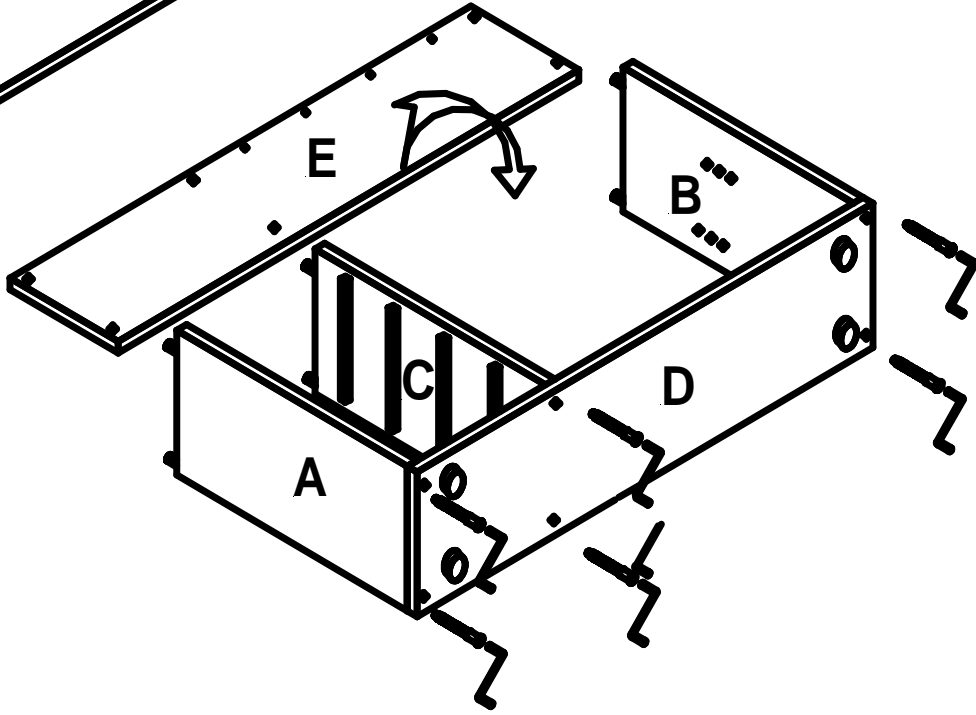

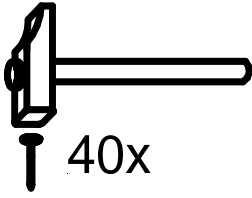
8.)  40x

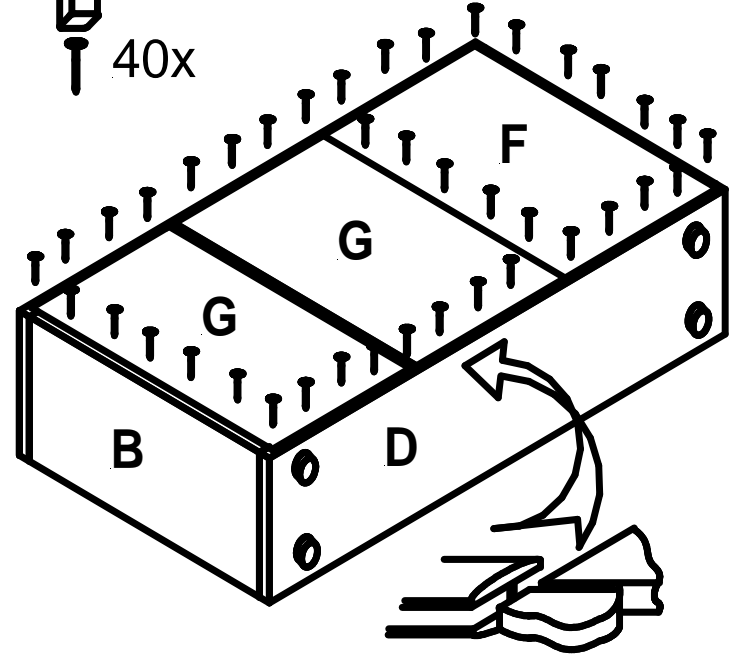

9.)

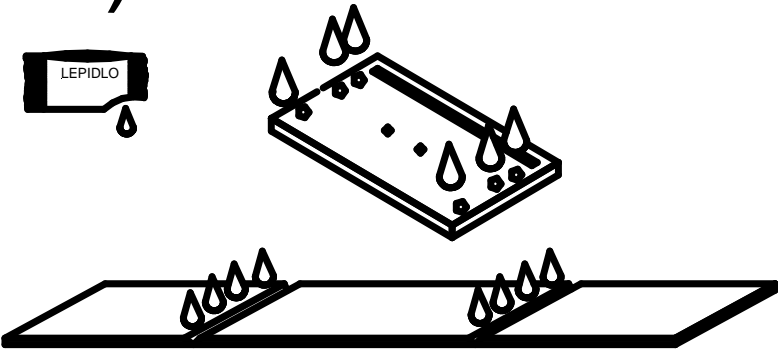
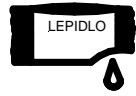

10.)

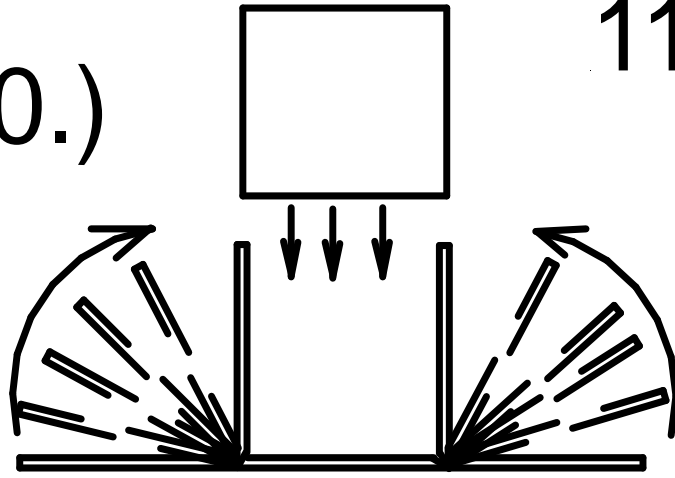

11.)

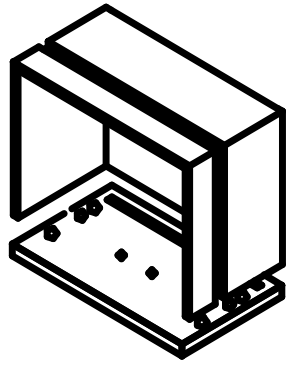

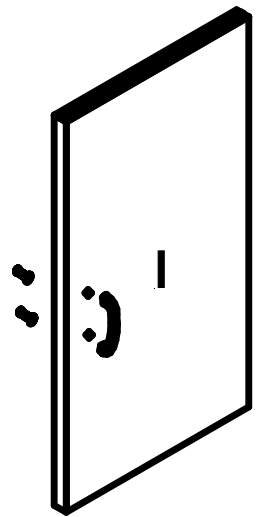
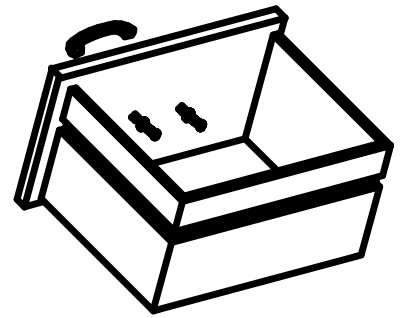

12.)  8x

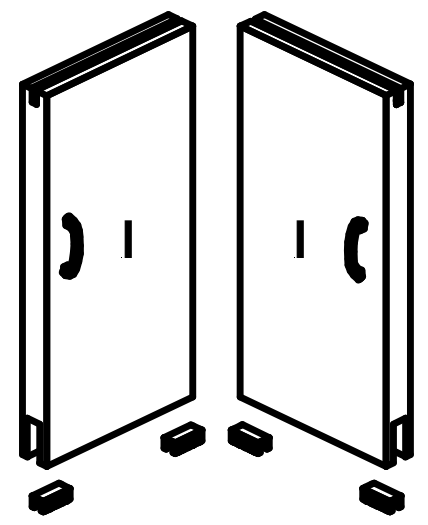

13.)  4x



14.)

 8x
 1x
 1x

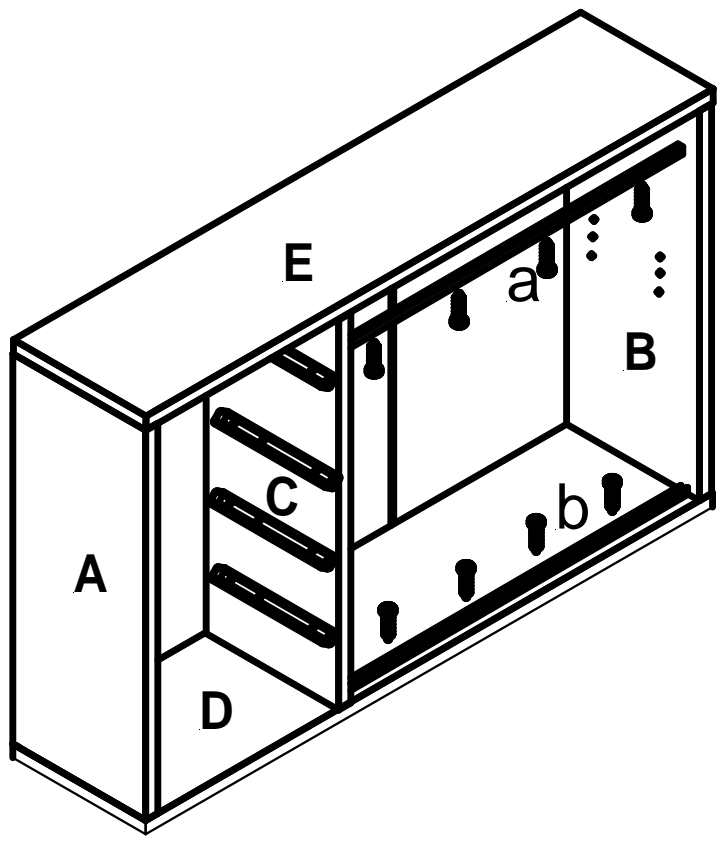

15.)

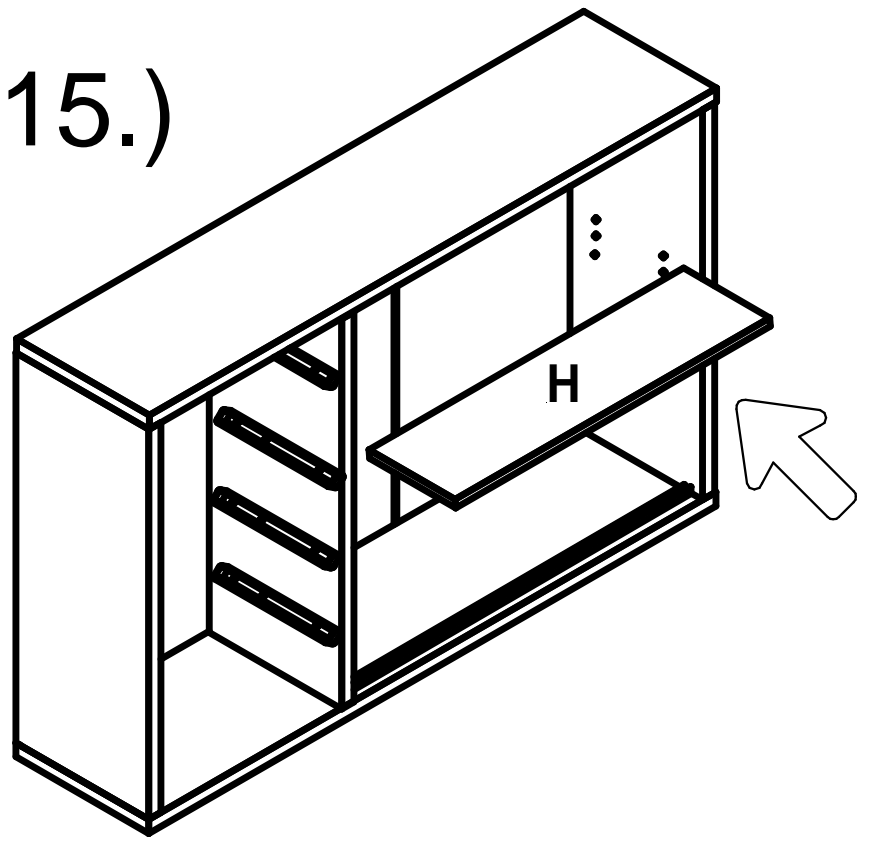

17.)

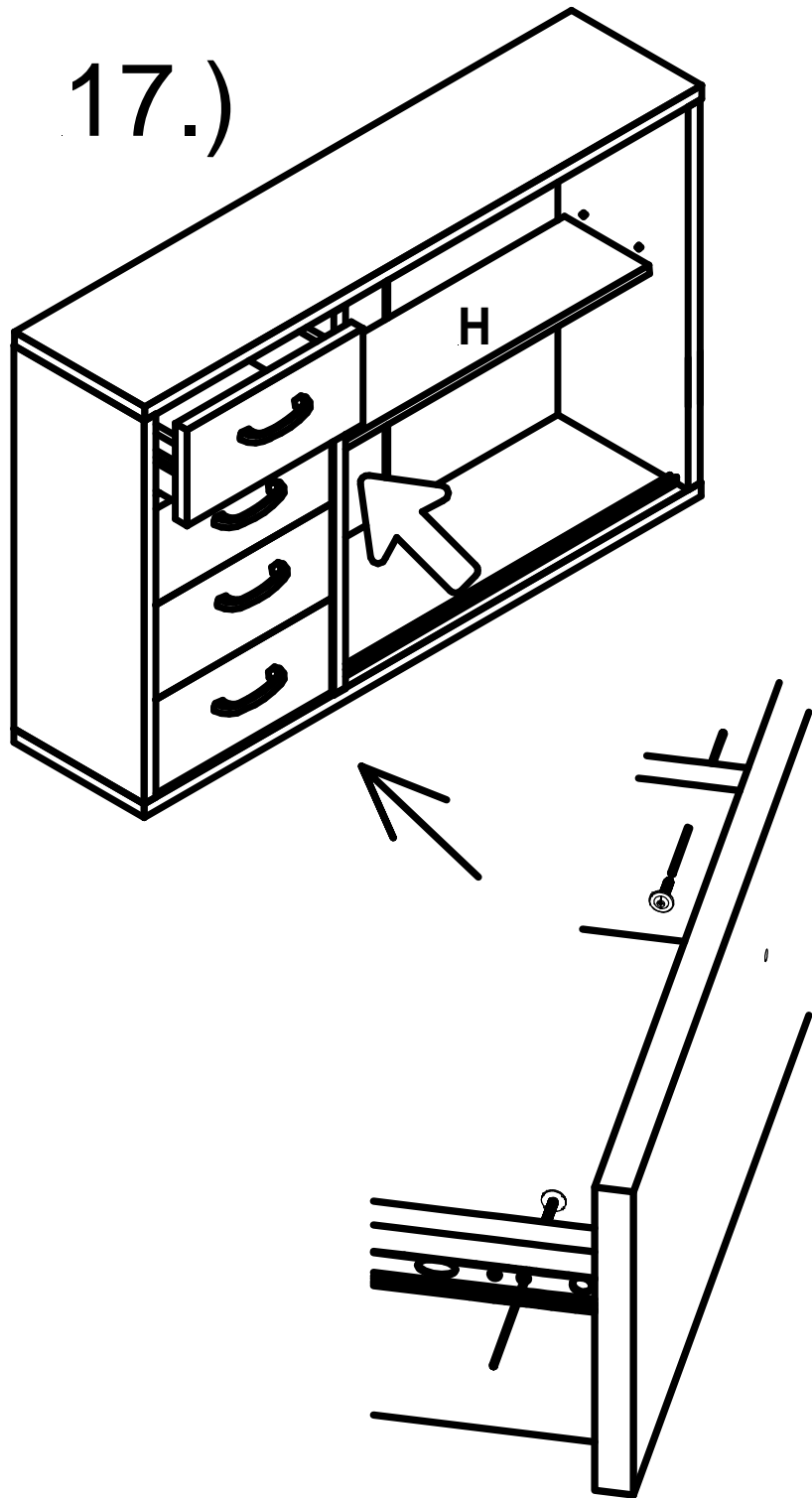

18.)

